

AI TAKAMUL COMPANY FOR ENGINEERING TESTING AND PROFESSIONAL SAFETY LIMITED

Basra, North Rumaila, Quality Control Yard - Iraq: Tel: +9647810009138 / +9647834964657
 Email: OP@qualitycontrol-iraq.com / hany.akafi@qualitycontrol-iraq.com



CERTIFICATE OF VISUAL AND MAGNETIC PARTICLE INSPECTION AND ULTRASONIC THICKNESS GAUGING

THIS REPORT COMPLIES WITH RECOGNIZED INTERNATIONAL STANDARDS & TECHNICAL REQUIREMENTS

CLIENT:	ZHONGMAN PETROLEUM AND NATURAL GAS GROUP. Co. Ltd. Iraq Branch	REPORT NO:	QC-06-24-0190-HP-005
RIG & LOCATION:	ZPEC - 25 / RU - 620	JOB NO:	QC-ZPEC-JUN-24-0190
INSPECTION DATE:	25-Jun-2024	DUE DATE:	ANNUAL INSPECTION
UNIT NAME:	HIGH-PRESSURE LINE STRATE JOINT (Rig Side In Ground)	MFG SERIAL NO:	HP - 05
DESCRIPTION:	4" X 5K	SPECIFICATION:	ASTM E 709 / ASTM E 797
TYPE OF INSPECTION:	VISUAL INSPECTION AND ULTRASONIC WALL THICKNESS MEASUREMENT		

INSPECTION DETAILS:

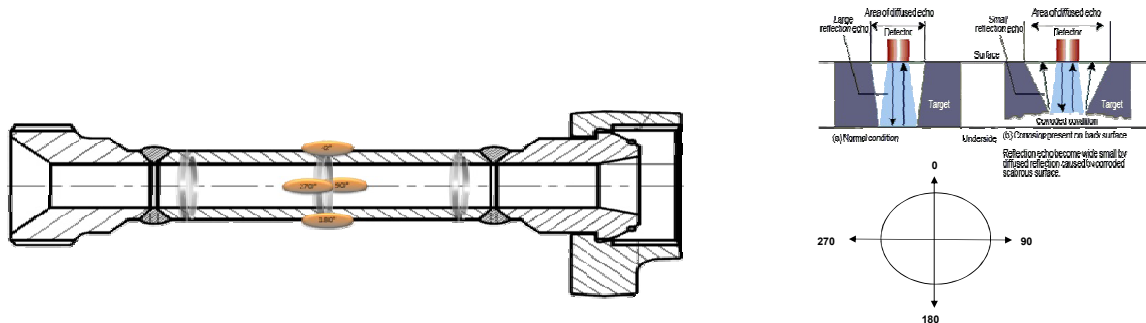

A: 0° 12'O CLOCK / FORWARD
 B: 90° 3'O 90° CLOCK / CENTER
 C: 180° 6'O CLOCK / AFT
 D: 270° 9'O CLOCK / PORT
 ***ALL READINGS IN MM:
 ***MINIMUM THICKNESS PROVIDED BY CLIENT:

ANGLE:	THICKNESS AT POSITION:				MIN: THICKNESS	REMARKS
	A	B	C	D		
0°	15.560	15.707	15.818	15.631	11.98 mm	Accepted
90°	15.880	16.027	15.792	15.491	11.98 mm	Accepted
180°	15.539	15.419	15.664	15.806	11.98 mm	Accepted
270°	15.341	15.695	15.495	15.882	11.98 mm	Accepted

INSPECTION RESULT:

UT	Accepted	***UT-The Above Item Was Found Acceptable As Per ASTM E 797 Acceptance Criteria and Also As Per Client Specification...
MPI	Accepted	*** MPI-The Above Item Weldment Area Had No Significant Discontinuous At The Time Of The Inspection And Was Found Acceptable in Accordance To ASTM E 709...

Inspection Evaluation

As Per OEM, The Readings Were Found Under The Acceptance Criteria At The Time of Inspection:

INSPECTION EQUIPMENT DETAILS:

UT THICKNESS GAUGE:	5500391	CAL DUE DATE:	14-Aug-2024
UT Test Block:	NoBo5087	CAL DUE DATE:	15-Aug-2024
Permanent Hand Magnet:	PY - 09	CAL DUE DATE:	15-Aug-2024
White Contrast WPC-2 / Magnaflux:	Batch No:220602	EXPIRE DATE:	Jun - 2025
Black Ink 7HF / Magnaflux:	Batch No:220605	EXPIRE DATE:	July - 2025

PERSON DETAILS:		REVIEW BY:		CLIENT:	
INSPECTOR NAME:	Syed Aamir Ali	SENIOR INSPECTOR:	Naveed Hussain	CLIENT:	ZPEC
QUALIFICATION:	ASNT LEVEL II VT,MT,PT,UT & LEEA III	INSPECTION SUPERVISOR:	Rao Suhail	H B & SIGNATURE:	

Original - Client Files Copy - Area Office QC/FN/UT/077 Rev.00 Dated: 07 Nov - 2021

