

MAJOR INSPECTION CERTIFICATE

THIS REPORT COMPLIES WITH RECOGNIZED INTERNATIONAL STANDARDS & TECHNICAL REQUIREMENTS

CLIENT:	HALLIBURTON	REPORT No.:	QC-24-01-TSS-013-NDT-MAJ-007
LOCATION:	TSS WORKSHOP & INSPECTION TEST AREA	STANDARD:	ASTM E709 & ASTM E797 & ASME SECTION V ARTICLE 5,10 & 27 & ASME B31.1
WORK ORDER #	326102061	SPECIFICATION:	Halliburton Acceptance Criteria H2S STANDARD NACE MQ-01-76
DATE OF INSP:	Thursday, January 25, 2024	INSP. DUE DATE:	ANNUAL INSPECTION
TYPE OF INSPECTION:	VISUAL INSPECTION, PRESSURE TEST AND MAGNETIC PARTICLE INSPECTION AND ULTRASONIC THICKNESS GAUGING		

DESCRIPTION:	BLOCK 3 1/16" 10K	CHOKE MANIFOLD #	12516007
MANUFACTURER:	WORLD WIDE OIL FIELD	SERIAL NO:	10120874-6-1
INSPECTION DETAILS			
Max. Working Pressure:	10,000 PSI	Holding Time:	19 Min
Low pressure:	300 PSI	Holding Time:	05 Min
Pump S.N.:	13119220 Cal DUE. AUG.2024	Pressure Gauge NO.:	468066 Cal DUE. AUG.2024

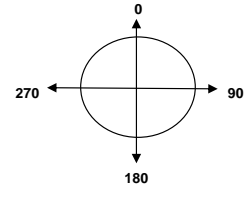
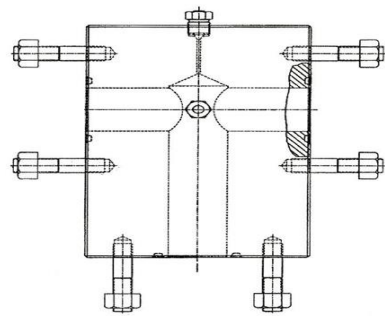
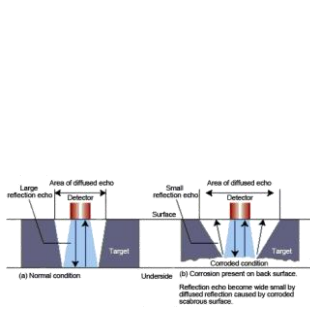

A:12'O CLOCK / FORWARD
B:3'O CLOCK / CENTER
C:6'O CLOCK / AFT
* ALL READINGS IN INCH
**MINIMUM THICKNESS PROVIDED BY CUSTMER

POINTS	THICKNESS AT POSITION			MINIMUM THICKNESS
	A	B	C	
0°	4.518	4.586	4.599	4.320
90°	4.525	4.528	4.529	
180°	4.539	4.562	4.619	
270°	4.557	4.565	4.574	

INSPECTION RESULT		
VT & MPI	Accepted	* ACCORDING TO ASTM E709(70.94158).
UT	Accepted	According to Halliburton Procedure (H2S STANDERD NACE MQ-01-76) ASME SECTION V ARTICLE 5 (ASTM E 797)
BODY	Accepted	*** These Are The Actual Readings Need To Follow As Per Halliburton Acceptance Criteria

Inspection Evaluation
(MPI) The Above Item Has No Significant Discontinuous At The Time Of Inspection And Found Acceptable Accordance To The Halliburton Specification ASTM E709 (70.94158)
U.T-The Above Item Was Found Acceptable As Per Halliburton Procedure H2S STANDARD NACE MQ-01-76 ASME SECTION V ARTICLE 5 (ASTM E 797)
Pressure Test-The Above Item was Pressure Tested up to 300 PSI A low Pressure Hold for 5 min And Maximum Working pressure 10.000 psi Hold 19 min no Leak was Realized while testing & Pressure Was Stable Accordance To Chart Recorder Attached

INSPECTION EQUIPMENT DETAILS				TECHNICAL DETAILS			
AC YOKE S.N:	201504048	CAL DUE DATE	14-Feb-24	White Contrast WCP-2	MANUFACTURER	BATCH NO	EXPIRE DATE
Digital Lux Meter WHITE LIGHT	2722003	CAL DUE DATE	16-Feb-24		Magnaflux	220602	JUN,2025
UT THICKNESS GAUGE:	3997	CAL DUE DATE	16-Feb-24	Black Magnetic Ink 7HF	MANUFACTURER	BATCH NO	EXPIRE DATE
UT TEST BLOCK:	NoBo5087	CAL DUE DATE	16-Feb-24		Magnaflux	220605	JULY,2025
ASTM Test Block:	1657	CAL DUE DATE	14-Feb-24	Fluorescent Magnetic Ink 7HF	1.2 to 2.4 ml/100 ml		
WHITE LIGHT INTENSITY:	3578 lux						

PERSON DETAILS				
INSPECTOR NAME:	M. Shahzad Ahmed	SENIOR INSPECTOR:	NAVEED HUSSAIN	CLIENT:
QUALIFICATION:	NDT Level 2, UT, VT, MPI	INSPECTION SUPERVISOR:	HANI ALI	HB&SIGN
SIGNATURE & STAMP:				DATE: